

FläktGroup[®]

AIRTREND Ltd
Predstavništvo u Beogradu
Kumanovska 14, 11000 Beograd
Tel: 011/3836886, 3085740
Faks: 011/3444113
e-mail: gobrid@eunet.rs
web: www.airtrend.rs

Exhaust valves KSO, KSOV and KSOS

TECHNICAL DATA





KSO, KSOV AND KSOS EXHAUST VALVES

KSO is an exhaust valve suitable for houses, offices, etc.

QUICK SELECTION

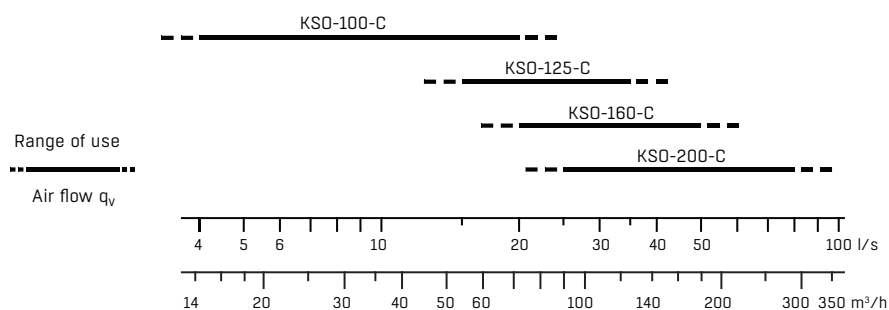

SPECIFICATIONS

- CleanVent coating as standard.
- Manufactured of sheet steel.
- Cone of the variant KSOV filled with attenuation material.
- Special KSOS typ for sauna with max working temperature 120 °C

PRODUCT CODE EXAMPLE

Exhaust valve KSO-100-C
Mounting ring KKT-100

SELECTION DIAGRAMS KSO AND KSOS

KSO-100-C

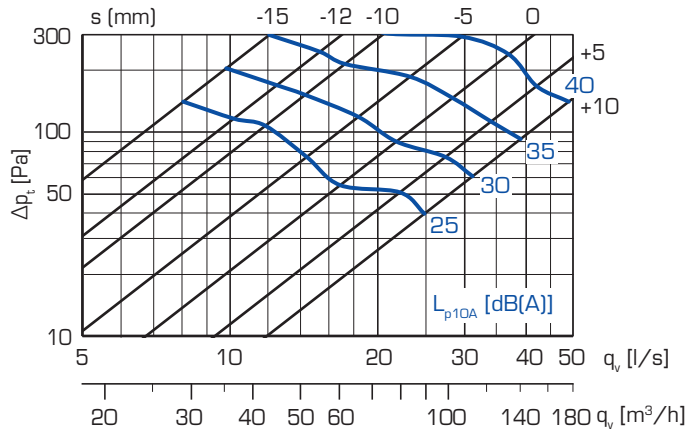

KSO-125-C

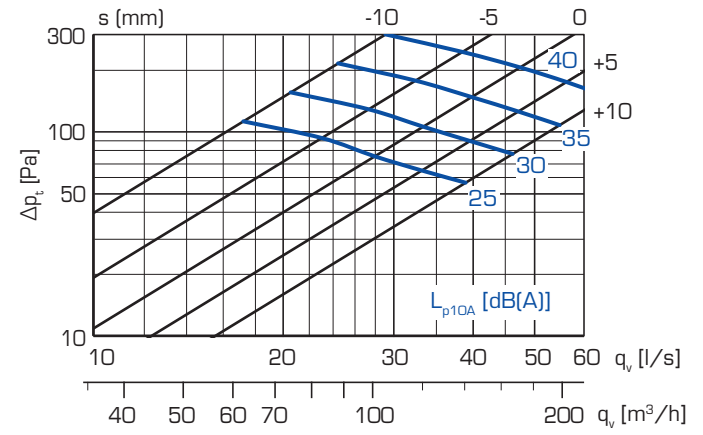

KSO-150-C AND KSO-160-C

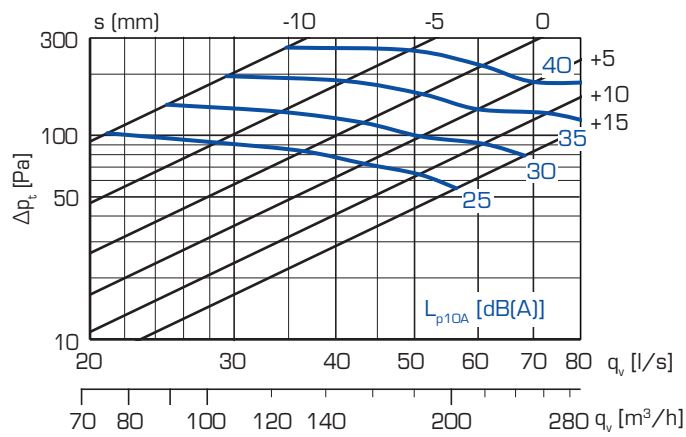

KSO-200-C

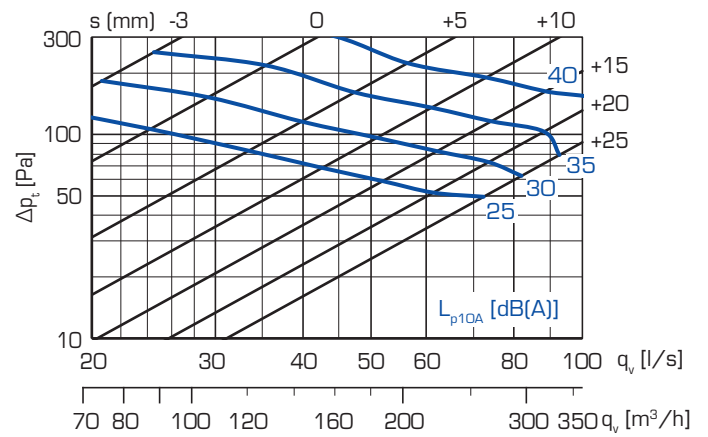

SELECTIONS DIAGRAMS KSOV + DBL

KSOV-100-C + DBL-100

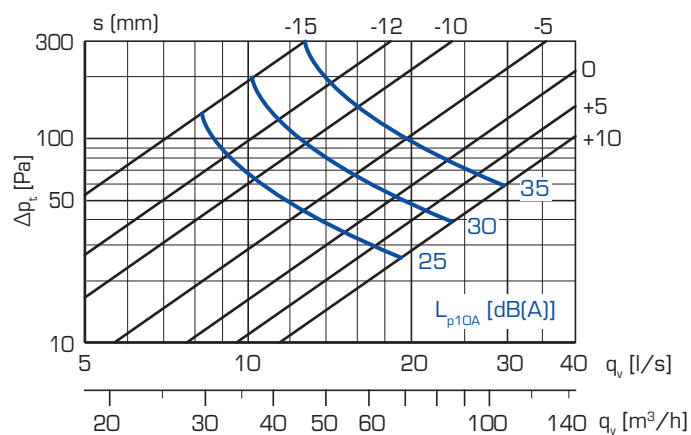

KSOV-125-C + DBL-125

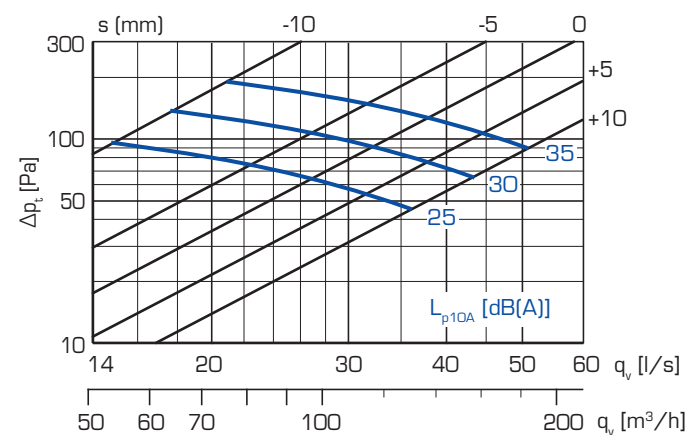

KSOV-160-C + DBL-160

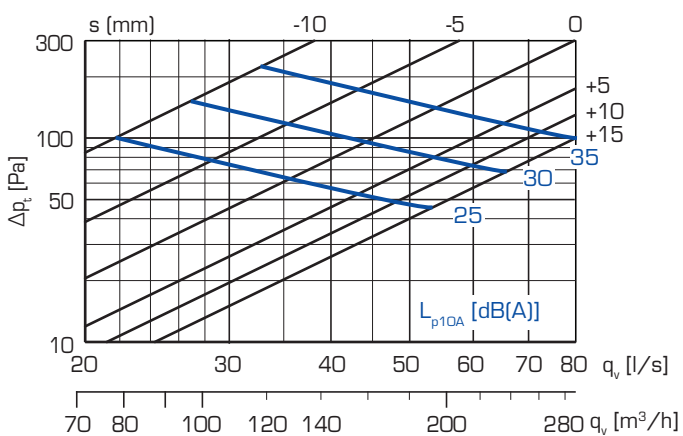

KSOV-200-C + DBL-200

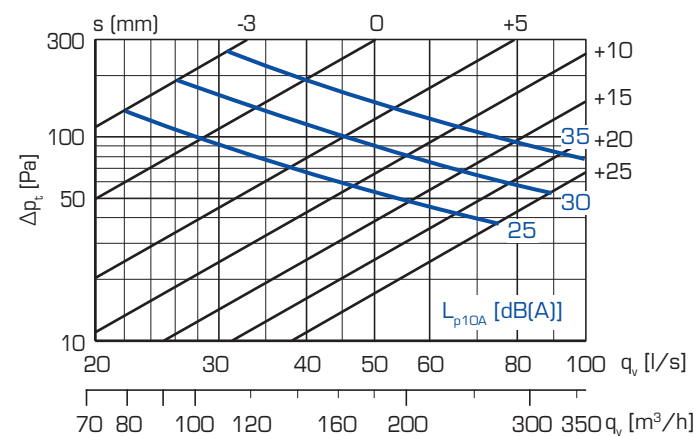

SOUND DATA

SOUND POWER LEVEL L_w

KSO KSOS	Correction of sound level K_{oct} (dB) at octave bands, middle frequency (Hz)							
	63	125	250	500	1000	2000	4000	8000
100	16	5	-3	-2	0	-3	-6	-13
125	14	6	-3	-2	-3	0	-10	-14
160	16	4	-2	-1	0	-3	-10	-13
200	16	5	-2	-2	0	-4	-7	-13
Tolerance \pm	6	3	2	2	2	2	2	3

KSOV + DBL	Correction of sound level K_{oct} (dB) at octave bands, middle frequency (Hz)							
	125	250	500	1000	2000	4000	8000	
100	6	6	2	-3	-6	-9	-27	
125	7	8	2	-4	-8	-13	-29	
160	8	5	0	-4	-3	-6	-24	
200	2	3	-1	-3	-3	-5	-24	
Tolerance \pm	6	2	2	2	2	2	3	

Sound power levels by octave bands are obtained by adding to total sound pressure level L_{p10A} , dB(A) the corrections K_{oct} presented in the table according to the following formula:

$$L_{Woct} = L_{p10A} + K_{oct}$$

Correction K_{oct} is an average value in the range of use of KSO unit.

DEFINITIONS

q_v	Air volume	l/s, m ³ /h
Δp_t	Total pressure drop	Pa
L_{p10A}	Sound pressure level with 4 dB room attenuation (10 m ² sab)	dB(A)
L_{Woct}	Sound power level	dB
ΔL	Sound attenuation	dB
K_{oct}	Correction	dB

SOUND ATTENUATION ΔL

KSO KSOS	Sound attenuation ΔL (dB) at octave bands, middle frequency (Hz)							
	63	125	250	500	1000	2000	4000	8000
100	23	19	14	13	12	14	7	8
125	21	16	12	11	11	13	6	6
160	19	14	10	10	10	10	6	6
200	17	15	12	12	13	11	8	7
Tolerance \pm	6	3	2	2	2	2	2	3

KSOV + DBL	Sound attenuation ΔL (dB) at octave bands, middle frequency (Hz)							
	63	125	250	500	1000	2000	4000	8000
100	22	19	15	14	13	16	16	15
125	21	18	14	15	16	18	18	18
160	19	16	13	15	19	24	21	17
200	16	14	12	18	22	22	21	16
Tolerance \pm	6	3	2	2	2	2	2	3

KSOV	Sound attenuation ΔL (dB) at octave bands, middle frequency (Hz)							
	63	125	250	500	1000	2000	4000	8000
100	22	18	14	14	13	12	5	8
125	20	16	12	13	12	9	6	8
160	19	14	11	12	13	12	6	8
200	14	12	10	13	14	12	8	9
Tolerance \pm	6	3	2	2	2	2	2	3

The average sound attenuation ΔL from duct to room including the end reflection of the connecting duct in ceiling installation, is obtained in the table above. ΔL values correspond positions $s = 0$ mm (sizes 100-160) and $s = 10$ mm (size 200).

DIMENSIONS AND WEIGHTS

KSO

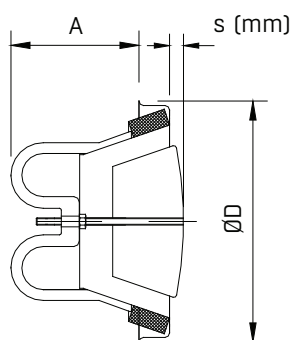

Size	ØD (mm)	A (mm)	Weight (g)
100	135	71	280
125	161	85	360
150	191	85	470
160	191	85	470
200	241	107	720

KKT, KKL

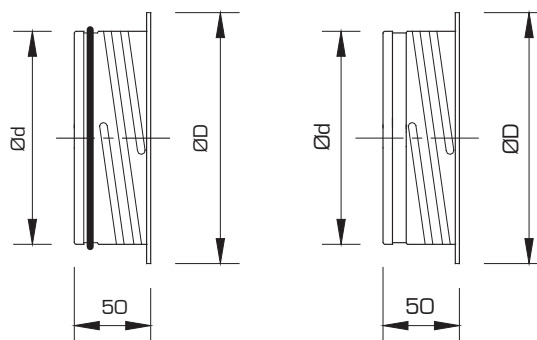

Size	Ød (mm)	ØD (mm)	Weight KKT (g)	Weight KKL (g)
100	99	122	75	71
125	124	148	102	97
150	149	175	123	116
160	159	184	131	125
200	199	225	165	156

KSOV + DBL

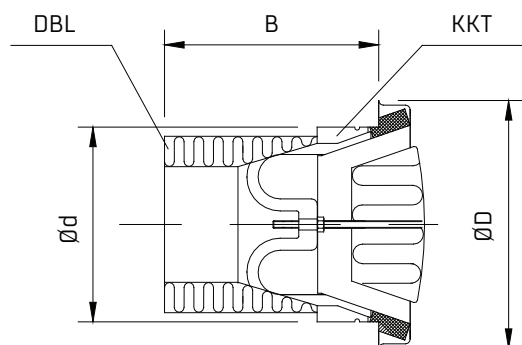

Size	ØD (mm)	Ød (mm)	B (mm)	Weight (g)
100	135	99	75	360
125	161	124	110	550
160	191	159	200	985
200	241	199	300	1720

KKU

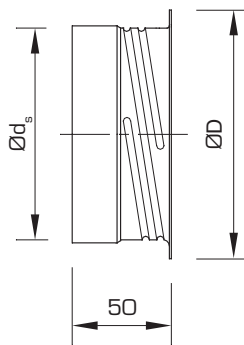

Size	Ød _s (mm)	ØD (mm)	Weight (g)
100	100	122	71
125	125	148	97
150	150	175	116
160	160	184	125
200	200	225	156

KSOS

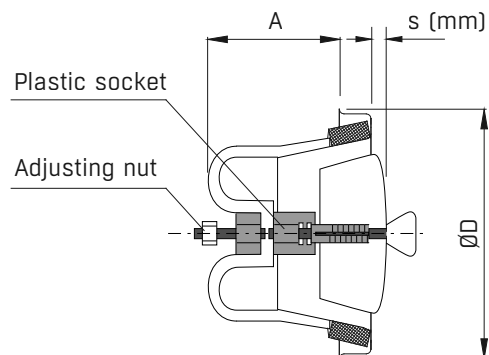

Size	ØD (mm)	A (mm)	Weight (g)
100	135	71	310
125	161	85	390

ADJUSTMENT AND GENERAL

ADJUSTMENT

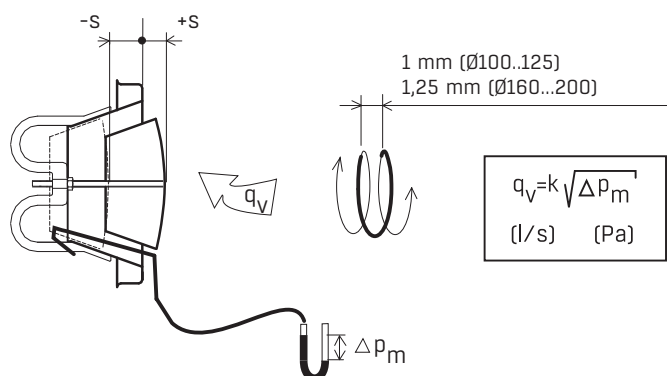

Size	100						
s	-15	-12	-10	-5	0	5	10
k-factor	0.5	0.8	1.0	1.4	1.9	2.3	2.8

Size	125				
s	-10	-5	0	5	10
k-factor	1.5	2.1	2.7	3.3	4.0

Size	150/160					
s	-10	-5	0	5	10	15
k-factor	2.0	2.8	3.6	4.4	5.3	6.2

Size	200						
s	-3	0	5	10	15	20	25
k-factor	1.8	2.4	3.8	5.0	6.3	7.5	8.6

CONSTRUCTION

KSO is an exhaust valve suitable for houses, offices etc. It is made of sheet steel and powder coated in white (RAL 9010). CleanVent coating as standard. Other colours are available to special order. The body is equipped with cellular plastic gasket to form an airtight seal. Adjustment of the air flow is simple, the inner cone being rotated to the required setting and locked in the position with a single nut.

The body of KSOJ valve has attachment springs that enable, when regulations permit, the valve to be connected to a duct without a mounting ring.

Sauna valve KSOS can be opened and closed simply by pushing or pulling the wooden knob. Max. opening is adjusted by adjusting nut. Min. opening, which is preadjusted into pos. 0 mm, can be adjusted by shortening the plastic socket. Max. working temperature 120 °C.

The cone of KSOV valve is filled with attenuation material.

The body of DBL sound attenuator is made of hot galvanized sheet steel and inner part of glass fiber felt coated mineral wool.

Mounting rings KKT, KKL and KKV are made of hot galvanized sheet steel. The airtight mounting ring KKT is equipped with rubber sealing.

INSTALLATION

Mounting ring KKT, KKL or KKV is fitted into the duct with screws or rivets.

The valve is fitted into the ring so that both ends of the truss support the tracks of the ring firmly. KSO and KSOV valves are fitted into the mounting ring by rotating the arms of the body into firm contact with the raised grooves of the ring. DBL attenuator is fitted to the valve by pushing the attenuator to the fitting arms by using the slots in attenuator as cursor and then fitting the valve normally.

MEASUREMENT AND ADJUSTMENT OF THE AIR FLOW

The measurement of air flow is made as a pressure difference measurement with a separate measuring tube. Regulation of air volume is made by changing the position s. See the separate diagrams for measuring and regulation.

The diagrams are also valid when the valve is installed into 90° bend or T-piece within the limits of inaccuracy of measuring method.

Instructions for installation, adjustment and maintenance are available at www.flaktgroup.com.

TECHNICAL DATA AND DESIGN

For complete design details, please see the FläktGroup product selection program. The program can be found online at www.flaktgroup.com.

DESCRIPTIVE TEXT

Exhaust valve KSO, e.g. KSO-100 manufactured by FläktGroup.

PRODUCT CODE AND ACCESSORIES

PRODUCT CODE

Exhaust valve

Exhaust valve with springs

Exhaust valve with sound attenuator

Size (aaa)

100, 125, 150, 160, 200

Surface finish (b)

C = CleanVent coating (standard)

E = special colour

Exhaust valve for sauna

Size (aaa)

100, 125

Surface finish (b)

C = CleanVent coating (standard)

S = wood colour (TC9357)

KSO-aaa-b

KSOJ-aaa-b

KSOV-aaa-b

KSOS-aaa-b

ACCESSORIES

Sound attenuator

DBL-aaa

Size (aaa)

100, 125, 160, 200

Mounting ring with rubber gasket

KKT-aaa

Mounting ring without rubber gasket

KKL-aaa

**Mounting ring without rubber gasket,
mounted on the duct fitting**

KKU-aaa

Size (aaa)

100, 125, 150, 160, 200

SPARE PARTS

Seal

COGZ-aaa-1

Size (aaa)

100, 125, 160, 200

EXCELLENCE IN SOLUTIONS

FläktGroup is the European market leader for smart and energy efficient Indoor Air and Critical Air solutions to support every application area. We offer our customers innovative technologies, high quality and outstanding performance supported by more than a century of accumulated industry experience. The widest product range in the market, and strong market presence in 65 countries worldwide, guarantee that we are always by your side, ready to deliver Excellence in Solutions.

PRODUCT FUNCTIONS BY FLÄKTGROUP

Air Treatment | Air Movement | Air Diffusion | Air Distribution | Air Filtration
Air Management & ATD's | Air Conditioning & Heating | Controls | Service

» Learn more on www.flaktgroup.com
or contact one of our offices